

TOP

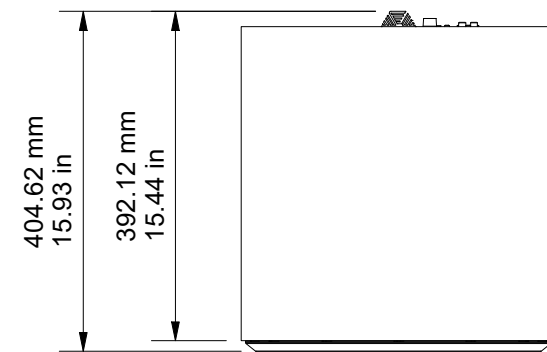

SIDE

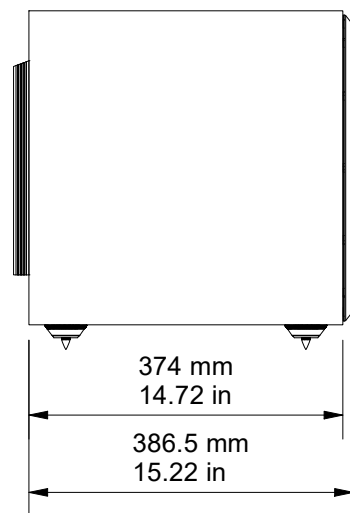

FRONT

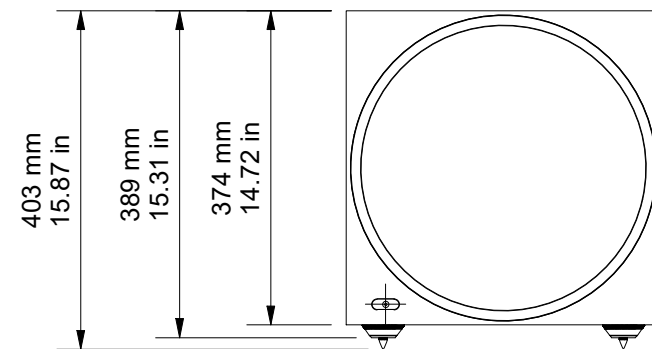

FRONT (GRILLE OFF)

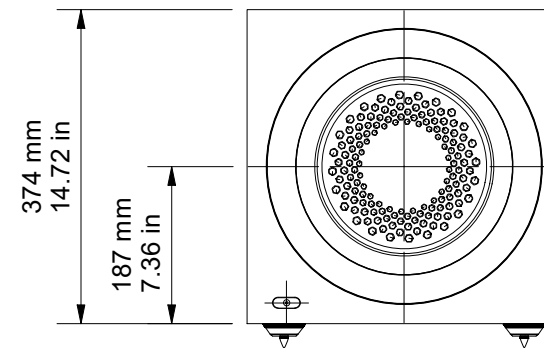

BACK

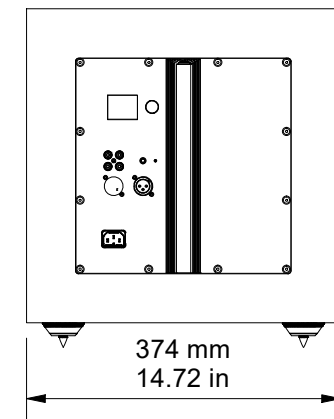

BASE

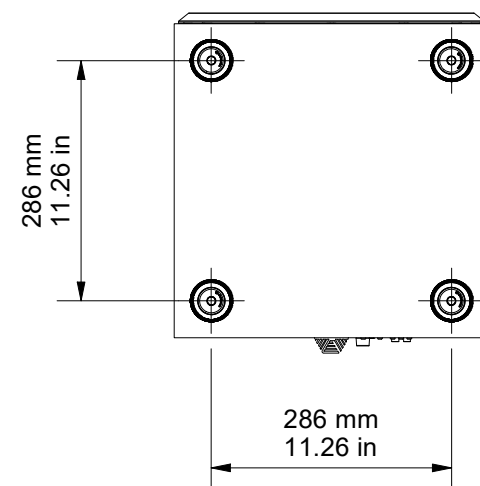

DRAWING FOR REFERENCE ONLY

W12



RANGE: ANTHRA

© COPYRIGHT MONITOR AUDIO

14/02/2023

